



L-Line Mikro Dissektoren

L-Line Mikro Dissectors

ERKLÄRUNG ZUM KATALOG-SYSTEM

Instructions for the catalogue system

PRODUKTZELLEN

Productcell

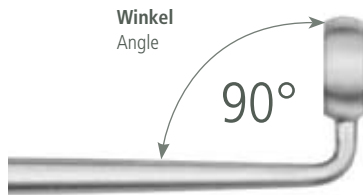

46.103

REF Artikelnummer
REF Cat. No.

6 mm
No. 3

Produktbeschreibung
Product description

FARBliche KENNZEICHNUNG

Colour Coding

Farbliche Markierungsringe unterteilen die Arbeitsenden in Kategorien und ermöglichen eine schnelle und sichere Identifikation.

Colored marking rings subdivide the working ends into categories and allow a quick and safe identification.



Memory
Memory



Scharf
Sharp





Diamant Messer
Diamond Knife



Stumpf
Blunt

FUNKTION

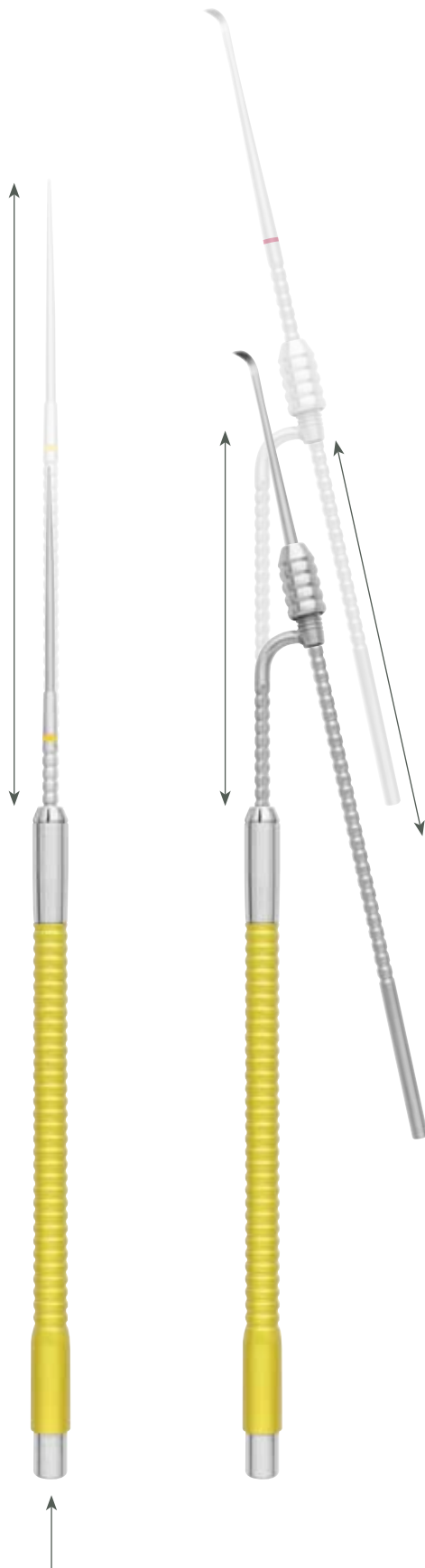
Function



Das einzigartige Konzept der L-Line Mikrodissektoren bietet eine Vielzahl von Variationsmöglichkeiten. Das Konzept ermöglicht eine individuelle Anpassung des Instruments an die chirurgisch notwendigen Gegebenheiten.

- **Länge:** Die Länge der Dissektoren ist individuell per Knopfdruck von 170 bis 240 mm einstellbar.
- **Form:** Bajonett oder gerade? Mit dem Bajonetteinsatz können sie in Sekunden das Instrument anpassen.
- **Vielfalt:** Mit über 90 verschiedenen Arbeitsenden bietet dieses System ein breites Spektrum von Haken, Dissektoren bis hin zu Diamantmessern.

The unique concept of the L-Line Micro dissectors offers a wide range of possibilities for variations. It enables an individual conformation of the instrument to the surgically necessary condition

- **Length:** the length of the Dissector is adjustable at the touch of a button (from 170 to 240 mm).
- **Form:** bayonet or straight? With the bayonet insert the instrument can be adapted in seconds.
- **Variety:** with more than 90 different working ends the system offers a broad range of hooks, dissectors right up to diamond scissors.

L-LINE MIKRO DISSEKTOREN

L-Line Micro Dissectors

ZUBEHÖR

Accessories

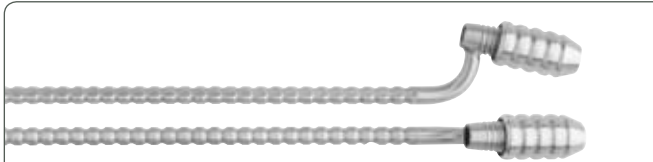

Bajonett Einsatz
Bayonet Inlay

46.095



Dissektor Handgriff
Dissector Handle

46.100

123 mm, 4 7/8"



Biegehilfe für Memory Dissektoren
Bending Tool for Memroy Dissectors

46.451

CONTAINER

Container



Lagerungscontainer für L-Line Dissektoren ohne Deckel
Storage tray for L-Line Dissectors without lid

46.025

265 x 175 x 34 mm

MEMORY-SET (170 – 240 MM, 6¾" – 9½")

Memory-Set (170 – 240 mm, 6¾" – 9½")

Memory Inside: Die Memory Dissektoren bieten die Möglichkeit das Instrument den gegebenen Bedürfnissen anzupassen. Nach anschließender Sterilisation erhält das Instrument seine ursprüngliche Form zurück.

Memory inside: The Memory Dissectors offer the possibility to adapt the instrument to the given needs. After sterilisation the instrument turns back into original condition.

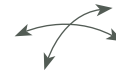

Kugeldissektor
 Teardrop Dissector

46.230

1 mm



Dissektor stumpf
 Dissector blunt

46.220

1,5 mm

46.221

2 mm



Dissektor stumpf, zylindrisch
 Dissector blunt, cylindric

46.225

0,8 mm



Dissektor stumpf, zylindrisch mit Lineal 30 mm
 Dissector blunt, cylindric with ruler 30 mm

46.226

0,8 mm

L-LINE MIKRO DISSEKTOREN

L-Line Micro Dissectors

CRANIAL SET (170 – 240 MM, 6¾" – 9½")

Cranial Set (170 – 240 mm, 6¾" – 9½")



Ringkurette
Ring Curette

46.101

46.102

46.103

2 mm

4 mm

6 mm



Ringkurette
Ring Curette

46.104

46.105

46.106

2 mm

4 mm

6 mm



Ringkurette
Ring Curette

46.107

46.108

46.109

2 mm

4 mm

6 mm



Ringkurette
Ring Curette

46.111

46.112

46.113

2 mm

4 mm

6 mm



Ringkurette
Ring Curette

46.114

46.115

46.116

2 mm

4 mm

6 mm



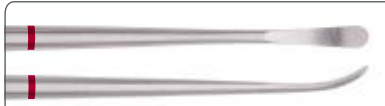

Dissektor scharf
 Dissector sharp

46.121

1 mm

46.122

2 mm

46.123

3 mm



Dissektor stumpf
 Dissector blunt

46.124

1 mm

46.125

1,5 mm

46.126

2 mm

46.127

3 mm

46.128

4 mm



Dissektor stumpf
 Dissector blunt

46.129

4 mm



Tellerdissektor stumpf
 Disc Dissector blunt

46.130

2 mm

46.131

4 mm



L-LINE MIKRO DISSEKTOREN

L-Line Micro Dissectors

CRANIAL SET (170 – 240 MM, 6¾" – 9½")

Cranial Set (170 – 240 mm, 6¾" – 9½")

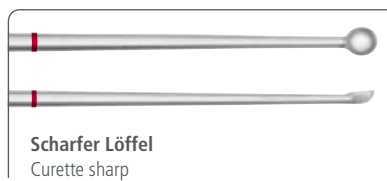

46.151

2 mm

46.152

3 mm

46.153

4 mm



46.154

2 mm

46.155

3 mm

46.156

4 mm

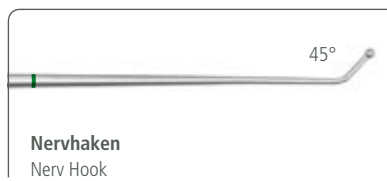

46.160

1 x 2 mm

46.161

1 x 4 mm

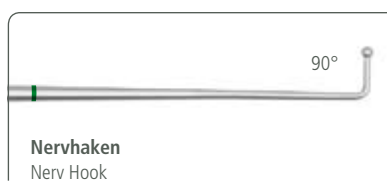

46.162

1 x 2 mm

46.163

1 x 3 mm

46.164

1 x 4 mm

46.165

1 x 5 mm

46.166

1 x 8 mm

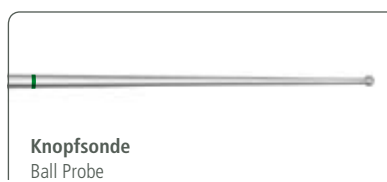

46.167

1 mm





45°

Nervhaken
 Nerv Hook

46.170

1 x 3 mm



90°

Nervhaken
 Nerv Hook

46.171 **46.172** **46.173**

1 x 3 mm 1 x 5 mm 1 x 8 mm



Nervhaken
 Nerv Hook

46.175

1 x 5 mm



90°

Nervhaken scharf
 Nerv Hook sharp

46.176

3 mm



90°

Nervhaken halbscharf
 Nerv Hook semi sharp

46.177 **46.178**

0,4 x 2 mm 0,4 x 3 mm



L-LINE MIKRO DISSEKTOREN

L-Line Micro Dissectors

CRANIAL-SET (170 – 240 MM, 6¾" – 9½")

Cranial-Set (170 – 240 mm, 6¾" – 9½")



Nadel
Needle

46.180



Lanzettmesser
Lancet Knife

46.140

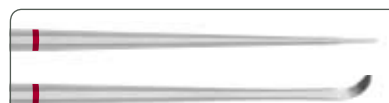

Sichelmesser
Sickle Knife

46.141



Zugmesser
Pulling Knife

46.142

3,5 mm



Tellermesser
Disc Knife

46.143

4 mm



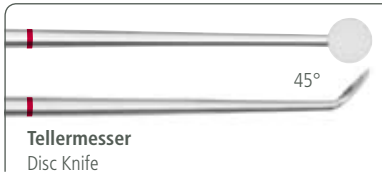

46.144

2 mm

46.145

4 mm



46.146

POLYTOM MESSER-SET (170 – 240 MM, 6¾" – 9½")

Polytom Knives-Set (170 – 240 mm, 6¾" – 9½")

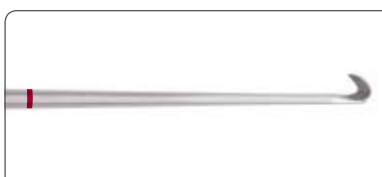

46.190

4 mm

46.191

5 mm



46.192

4,5 mm



L-LINE MIKRO DISSEKTOREN

L-Line Micro Dissectors

KNOCHEN-SET (170 – 240 MM, 6¾" – 9½")

Bone-Set (170 – 240 mm, 6¾" – 9½")

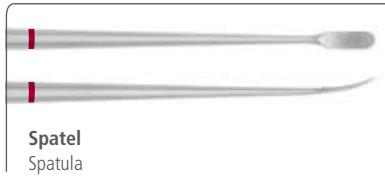

46.201

2,3 mm

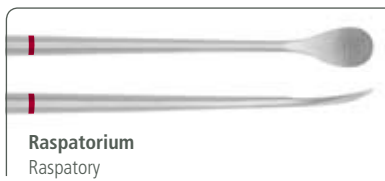

46.202

5 mm



46.207

3 mm



KNOCHEN-SET (FIXE LÄNGE, 190 MM, 7½")

Bone-Set (fix length, 190 mm, 7½")

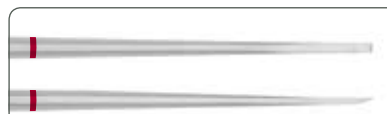

Mikro-Meißel
Micro-Chisel

46.209

1,2 mm

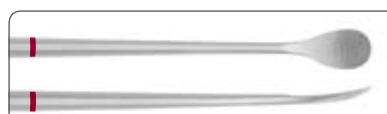

Raspatorium
Raspatory

46.203

10 mm

46.204

15 mm



L-LINE MIKRO DISSEKTOREN

L-Line Micro Dissectors

RHOTON-SET (170 – 240, 6¾" – 9½")

Rhoton-Set (170 – 240 mm, 6¾" – 9½")

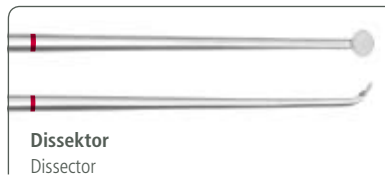

46.301

1 mm, #1

46.302

2 mm, #2

46.303

3 mm, #3



46.304

1,2 mm, #4

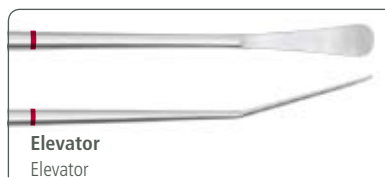

46.305

2,8 mm, #5

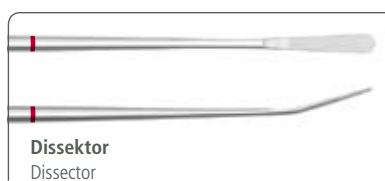

46.306

1 mm, #6

46.307

1,5 mm, #7

46.308

2 mm, #8

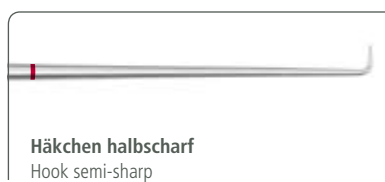

46.309

2 mm, #9



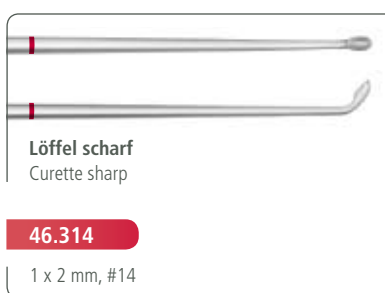
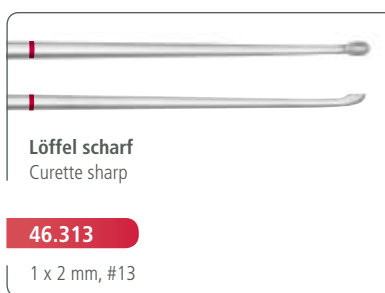
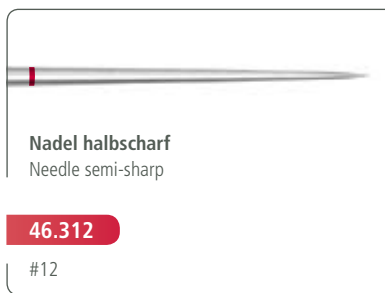
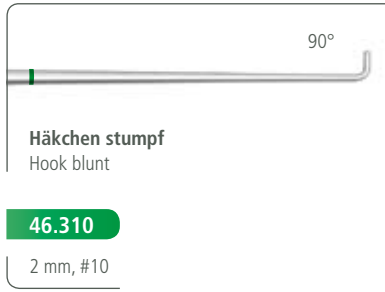

L-LINE MIKRO DISSEKTOREN

L-Line Micro Dissectors

RHOTON-SET (170 – 240, 6¾" – 9½")

Rhoton-Set (170 – 240 mm, 6¾" – 9½")



46.315

#15



46.316

#16



46.317

5 mm, #17

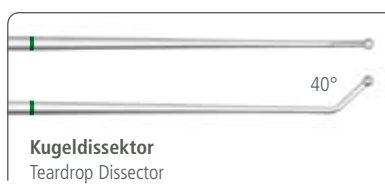

46.318

4 mm, #18



46.319

8 mm, #19





Diamant-Messer

Diamond-Knife

L-LINE MIKRO DISSEKTOREN

L-Line Micro Dissectors

DIAMANT-MESSER-SET (170 – 240 MM, 6¾" – 9½")

Diamant-Knife-Set (170 – 240 mm, 6¾" – 9½")

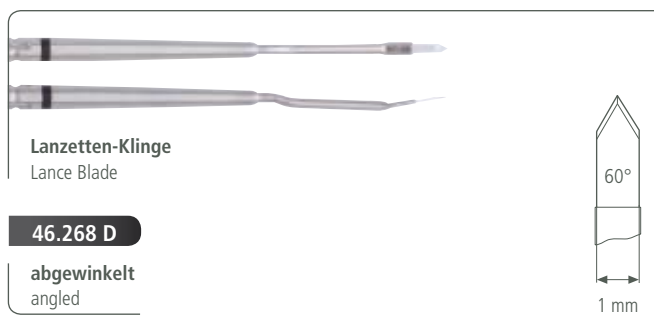
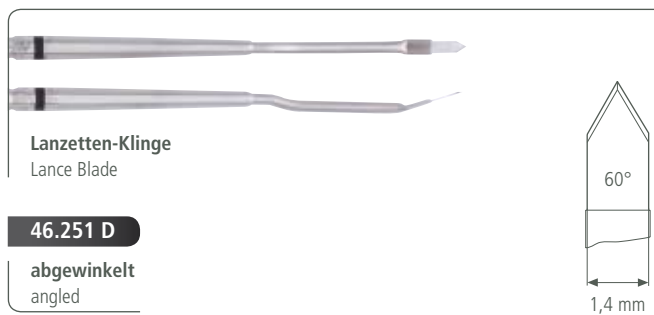
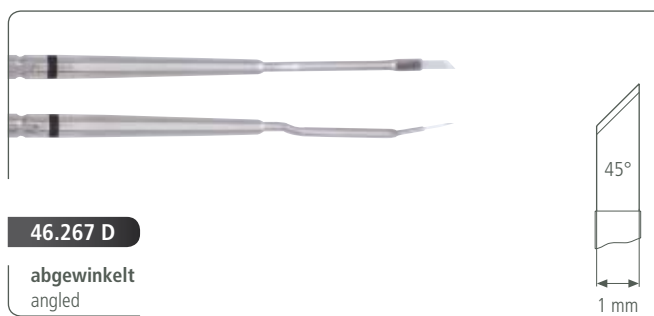
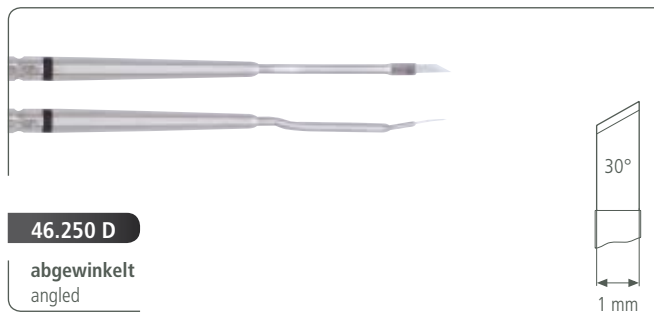

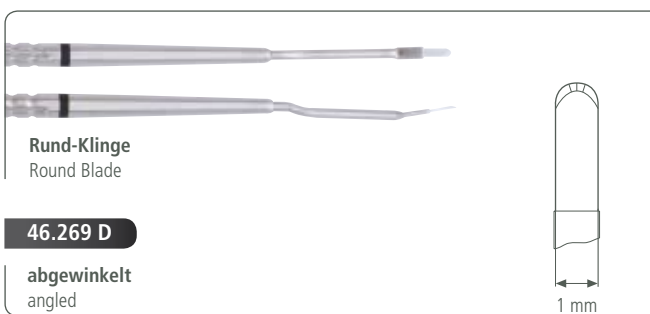
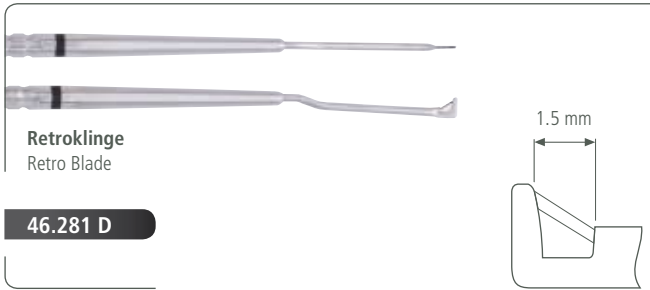

CONTAINER

Container



Lagerungs- und Reinigungscontainer für L-Line Diamant Messer
 Storage- and Cleaning Tray for L-Line Diamond Knives

46.026

für 5 Diamant Messer
180 x 95 x 37 mm
 for 5 Diamond Knives
 180 x 95 x 37 mm

46.027

für 10 Diamant Messer
180 x 136 x 37 mm
 for 10 Diamond Knives
 180 x 136 x 37 mm

ERKLÄRUNG DIAMANT-MESSER

Instruction Diamond-Knife

FUNKTION

Function

1. | Messerform

1. | Blade form

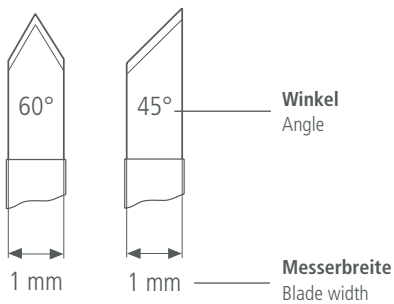

gerade
straight



abgewinkelt
angled



4. | Spülanschluss/Reinigung

Spülanschluss für einfache und effiziente Reinigung

4. | Rinsing-Connection/Cleaning
Built in flushing port for easy and efficient cleaning of internal components

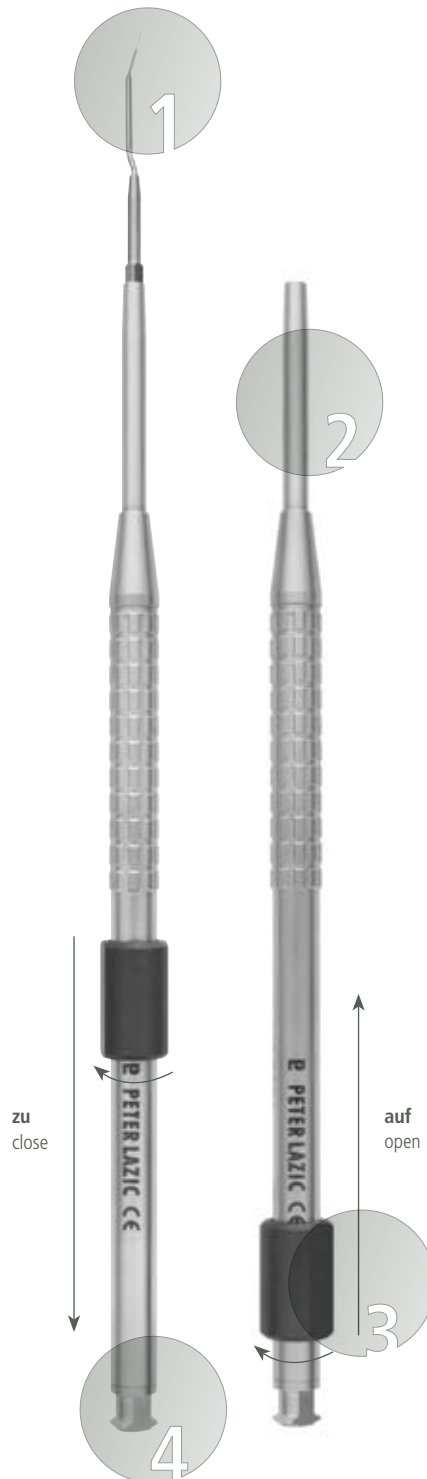

2. | Schutzhülse

Schützt Diamantklinge vor Beschädigungen bei nicht Gebrauch.

2. | Sleeve

Protects the diamond-blade against damages by not using.

3. | Öffnungs- und Verschlussmechanismus
Mit dem Öffnungs- und Verschlussmechanismus wird die Diamantklinge aus bzw. in die Schutzhülse gefahren.

3. | Opening- and Locking Mechanism
With the opening- and locking mechanism the diamond-blade can be driven in or out of the protective cover.

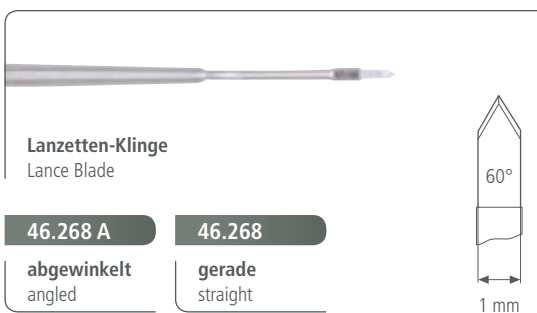
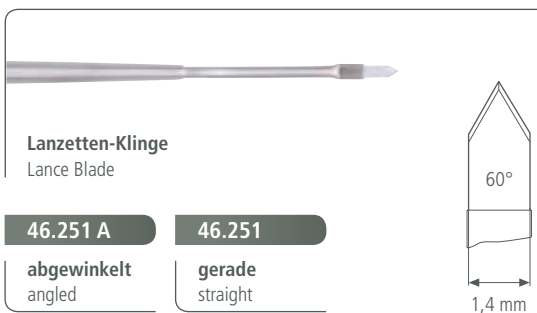
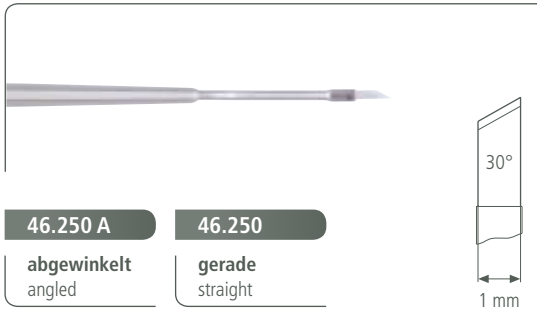

DIAMANT-MESSER

Diamond-Knife

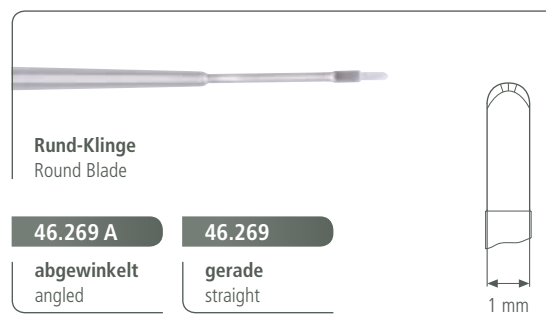
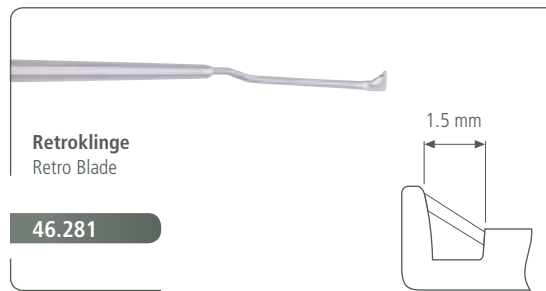



Rhoton-Set Classic

Rhoton-Set Classic

RHOTON-SET CLASSIC

Rhoton-Set Classic

RHOTON-SET (190 MM, 7½")

Rhoton-Set (190 mm, 7½")

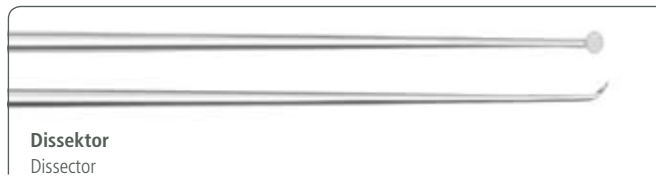

Dissektor
Dissector

46.361

1 mm, #1

46.362

2 mm, #2

46.363

3 mm, #3

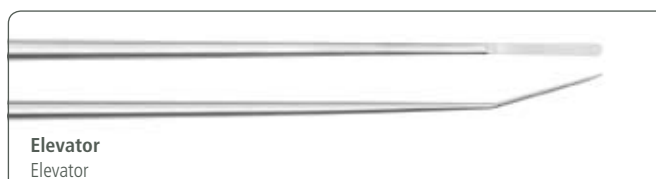

Elevator
Elevator

46.364

1,2 mm, #4

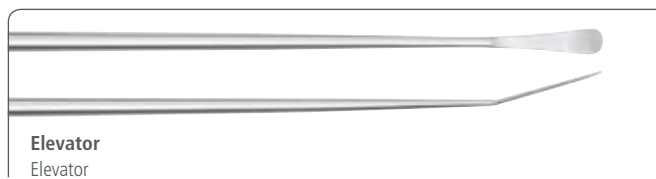

Elevator
Elevator

46.365

2,8 mm, #5

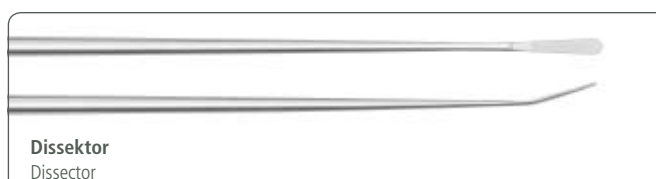

Dissektor
Dissector

46.366

1 mm, #6

46.367

1,5 mm, #7

46.368

2 mm, #8

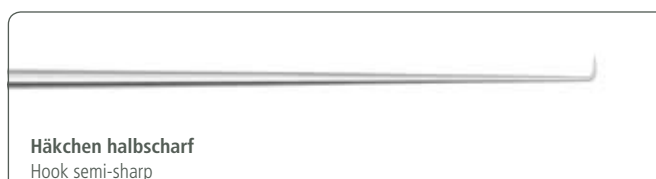

Häkchen halbscharf
Hook semi-sharp

46.369

2 mm, #9



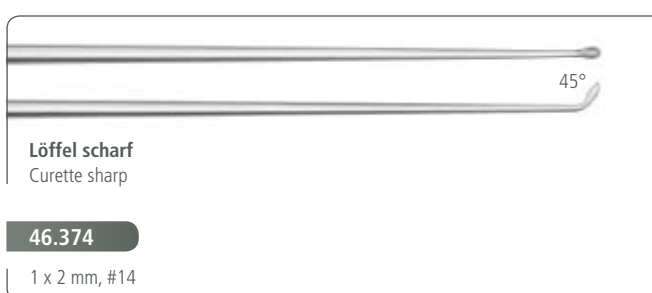
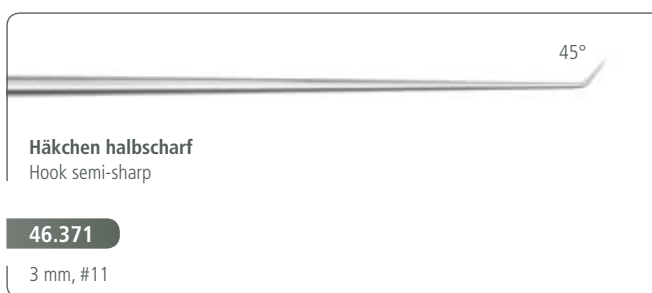

RHOTON-SET CLASSIC

Rhoton-Set Classic

RHOTON-SET (190 MM, 7½")

Rhoton-Set (190 mm, 7½")



Kugeldissektor
Teardrop Dissector

46.375

#15



Kugeldissektor
Teardrop Dissector

46.376

#16



Kugeldissektor
Teardrop Dissector

46.377

5 mm, #17



Kugeldissektor
Teardrop Dissector

46.378

4 mm, #18



Kugeldissektor
Teardrop Dissector

46.379

8 mm, #19



CONTAINER

Container



Lagerungs- und Reinigungscontainer für Rhoton Dissektoren
Storage- and Cleaning Tray for Rhoton Dissectors

46.028

260 x 210 x 26 mm



Peter Lazic GmbH

Mikrochirurgische Instrumente
Immelmannweg 2
D-78532 Tuttlingen

Tel. +49 (0) 7461 96643-0

Fax +49 (0) 7461 8745

info@lazic.de

www.lazic.de